

Dow Corning FES3000 Porous By-product

The Basics of Making Silicone

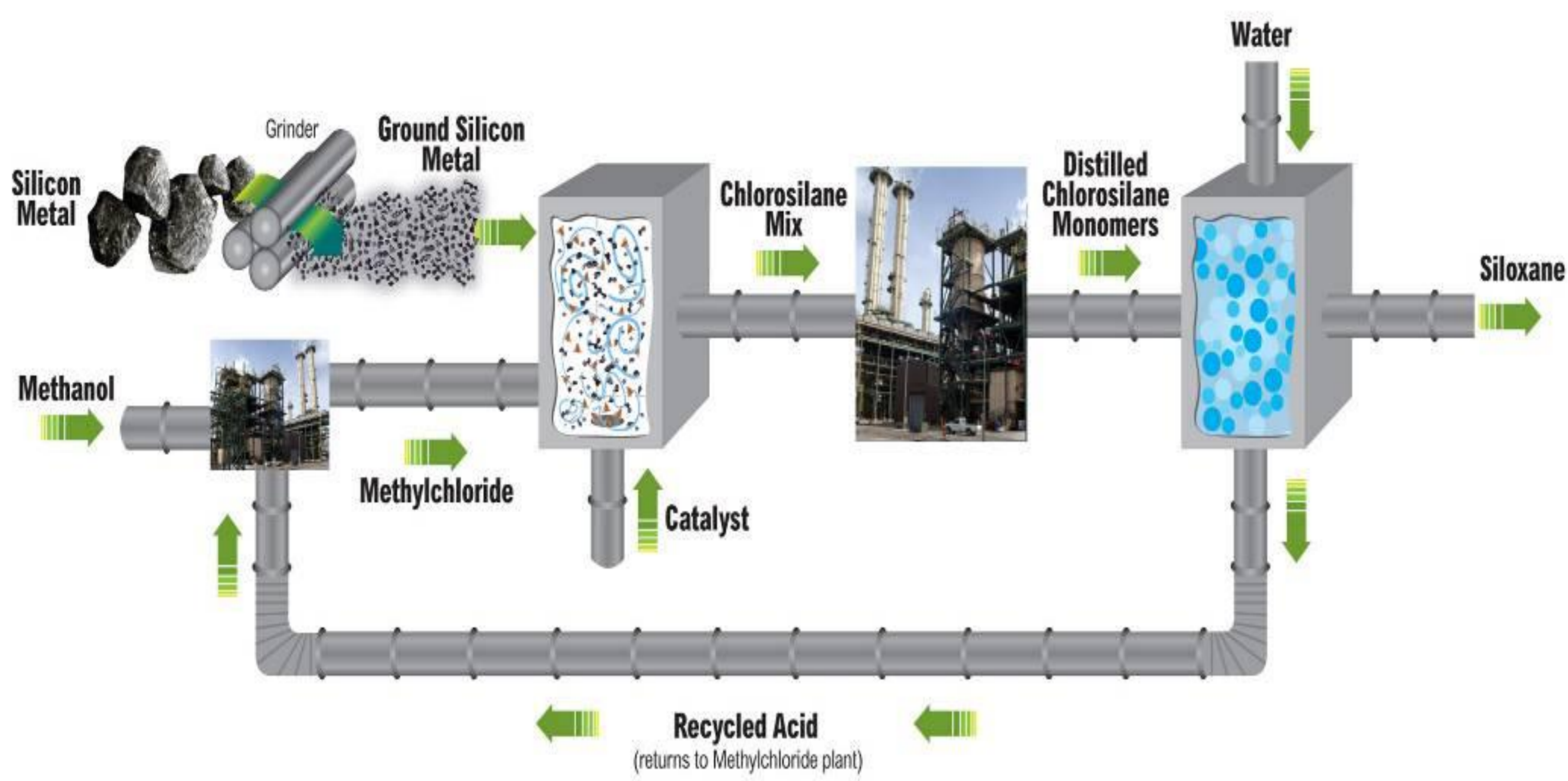

Silicon metal, methanol, energy, and capital = key cost drivers

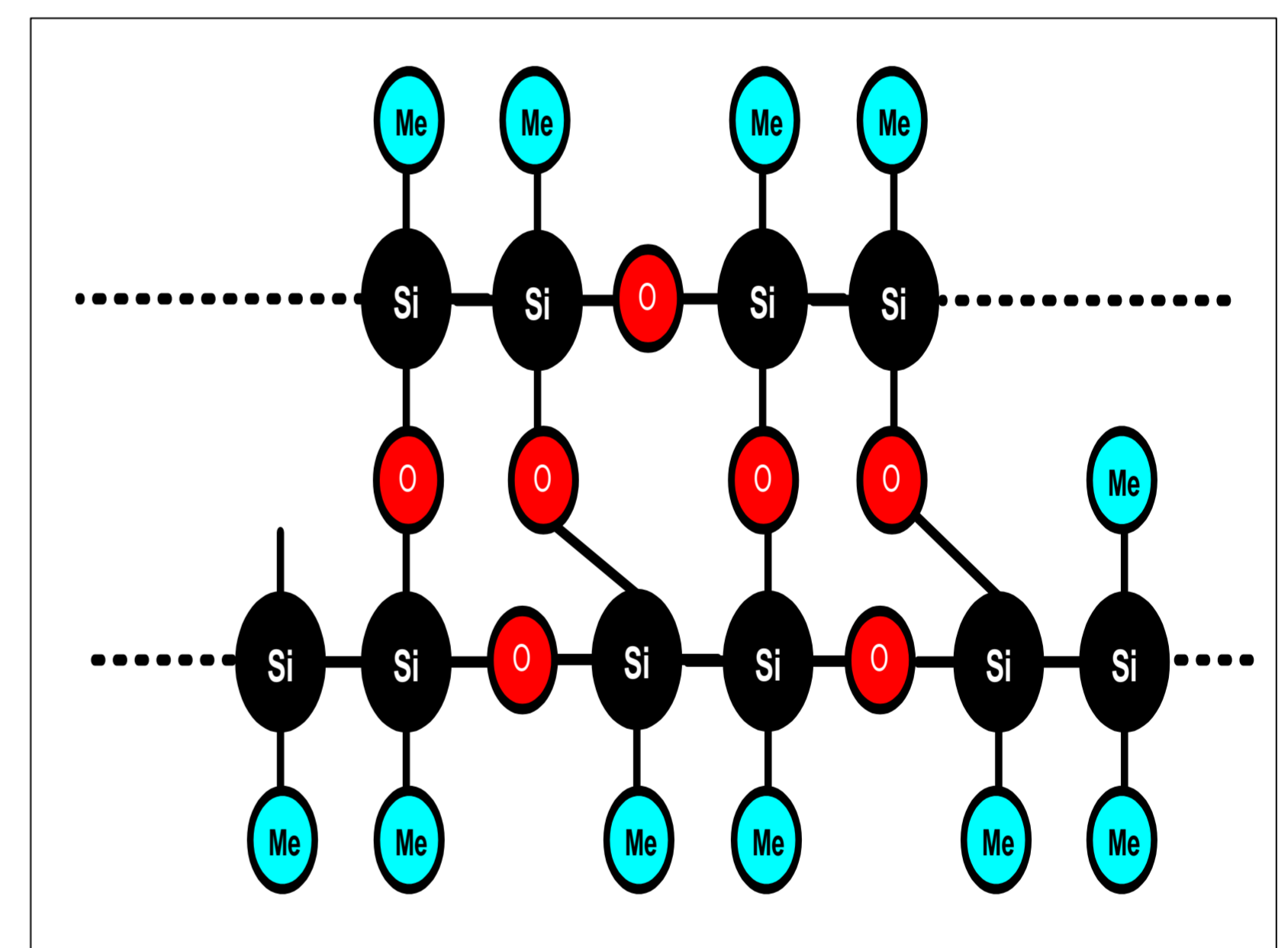
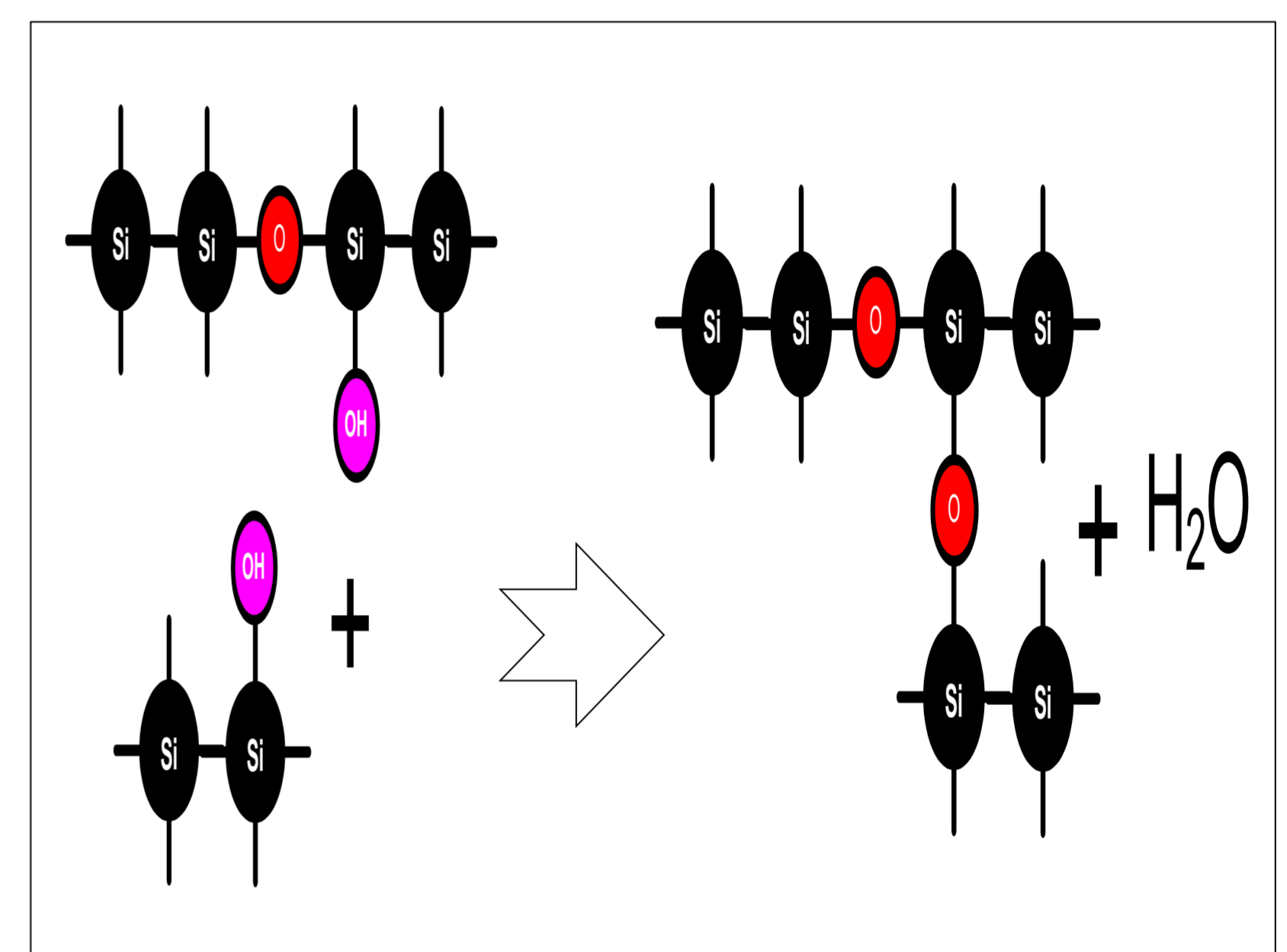
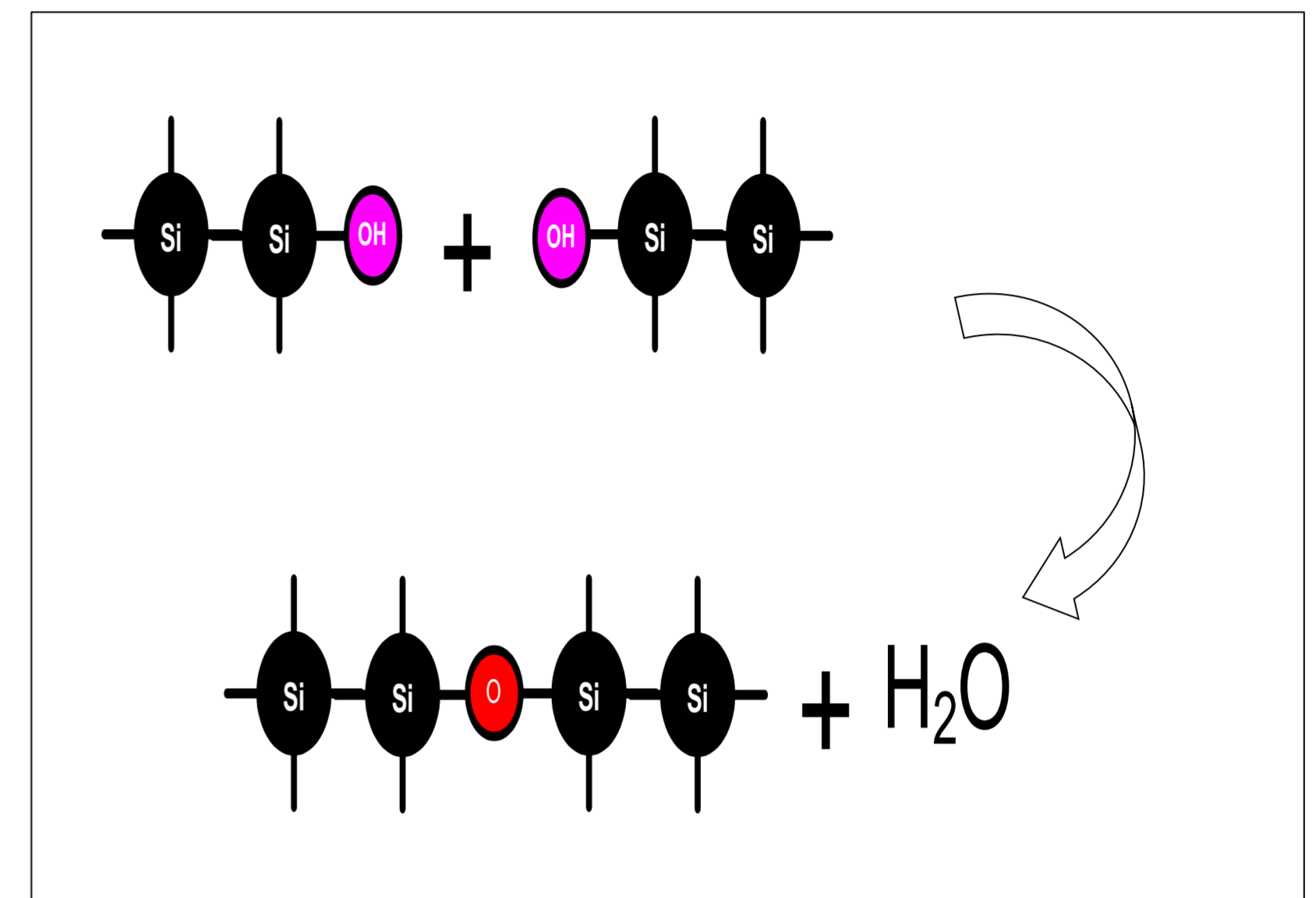
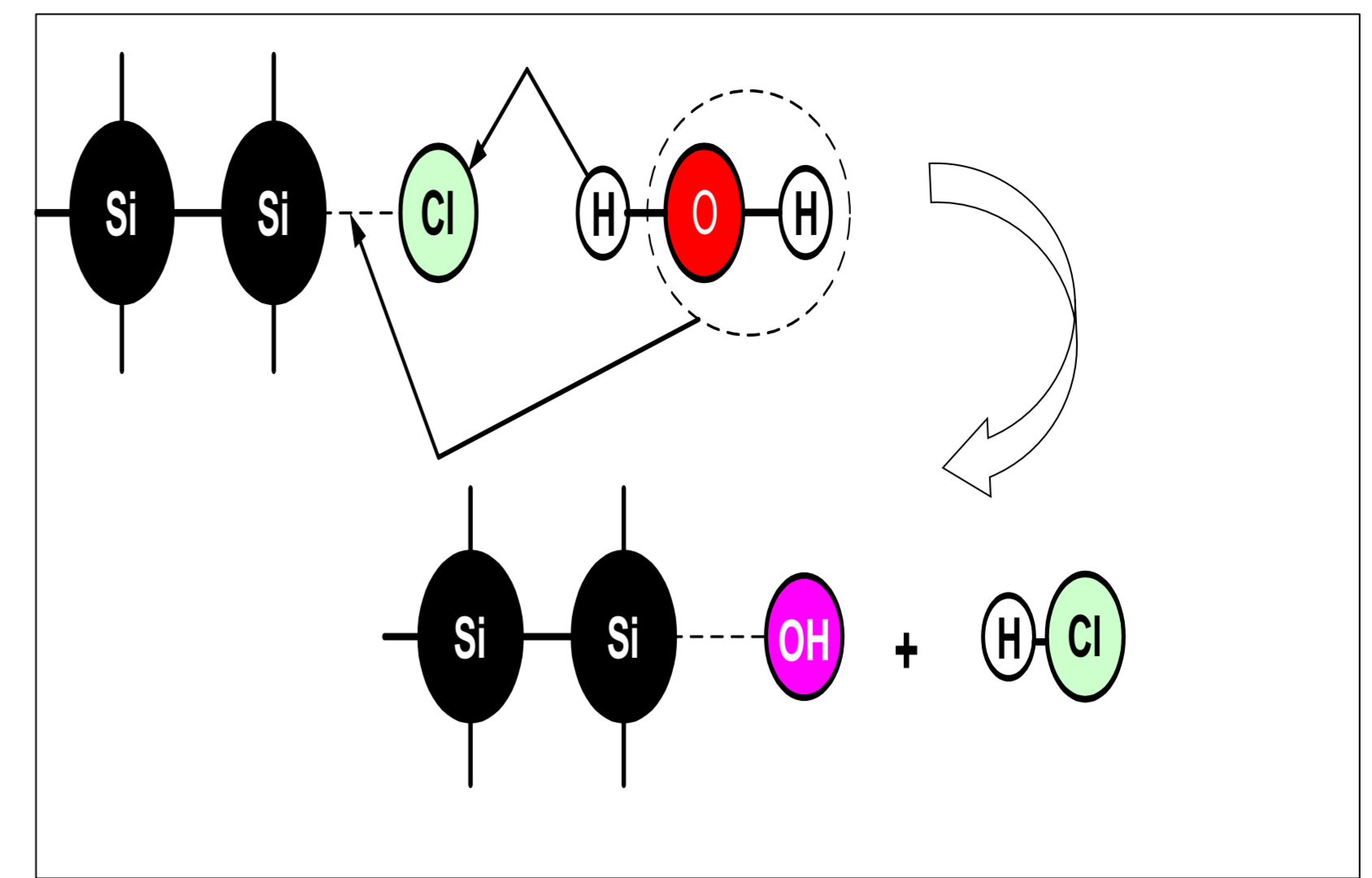

Process Overview – What is FES3000

The Rochow "Direct Process" for methylchlorosilanes

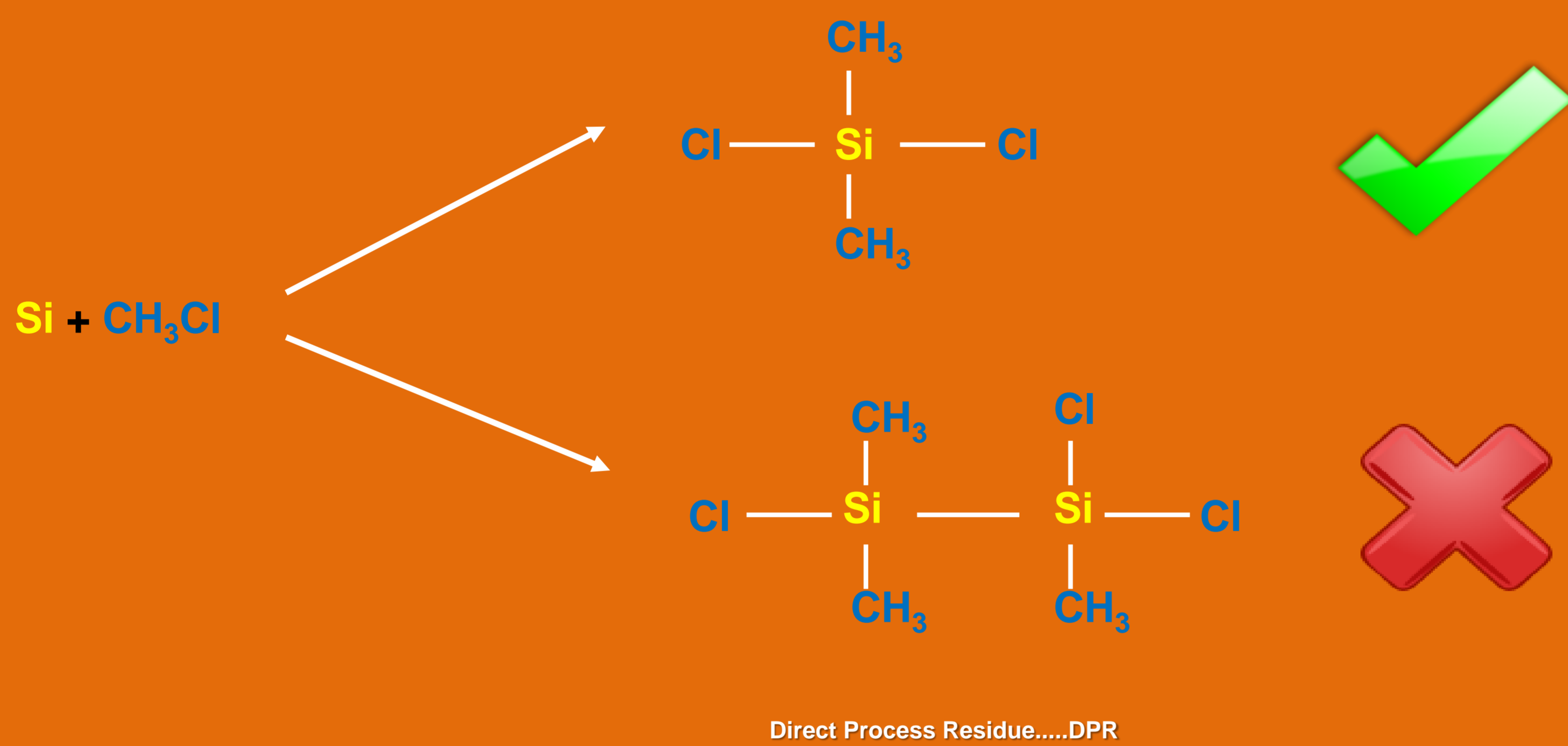

Removal of Metals from AMD

The Removal of Heavy Metal Ions from Wheal Jane Water by Zeolite (8g) Absorption

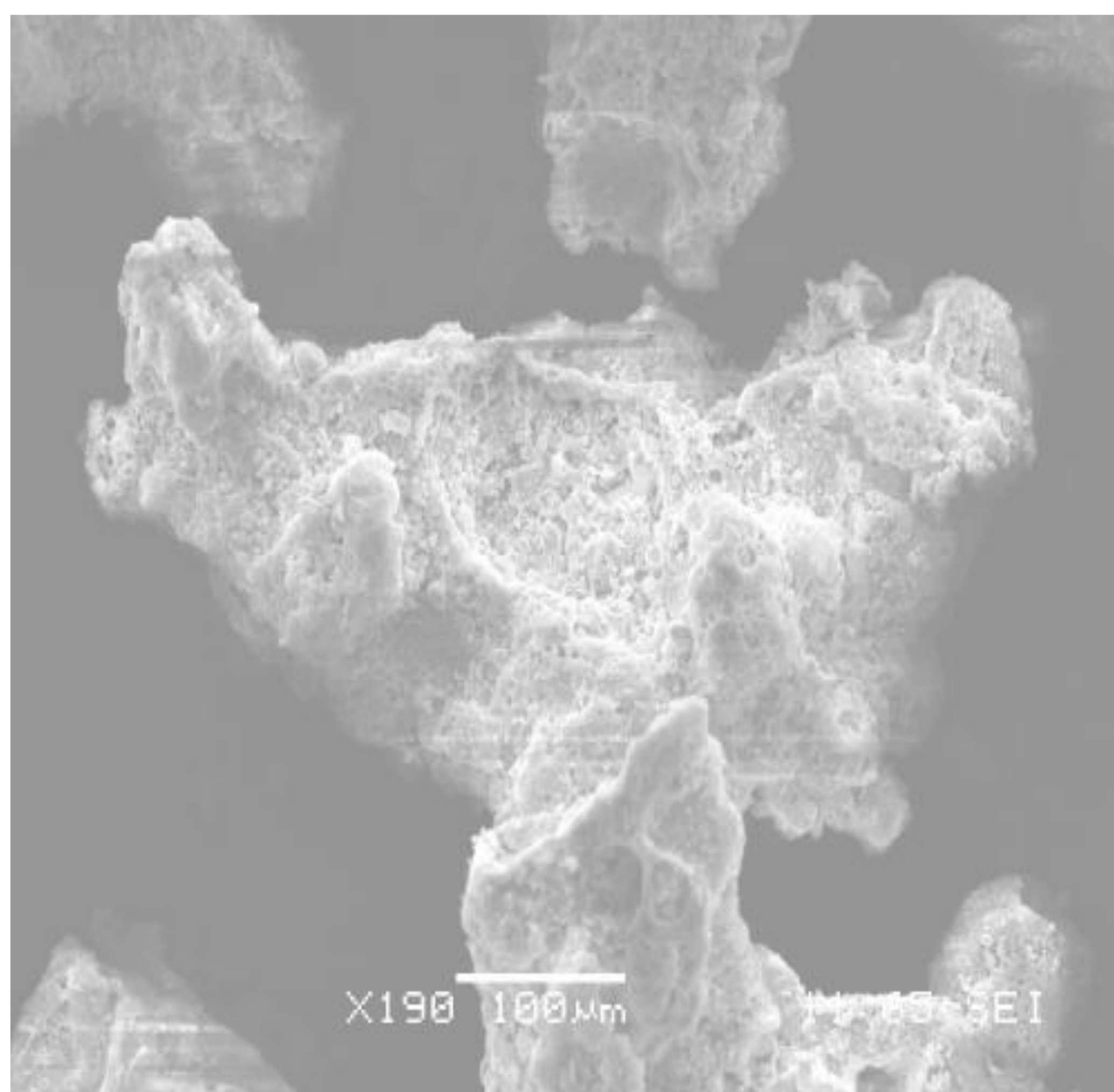
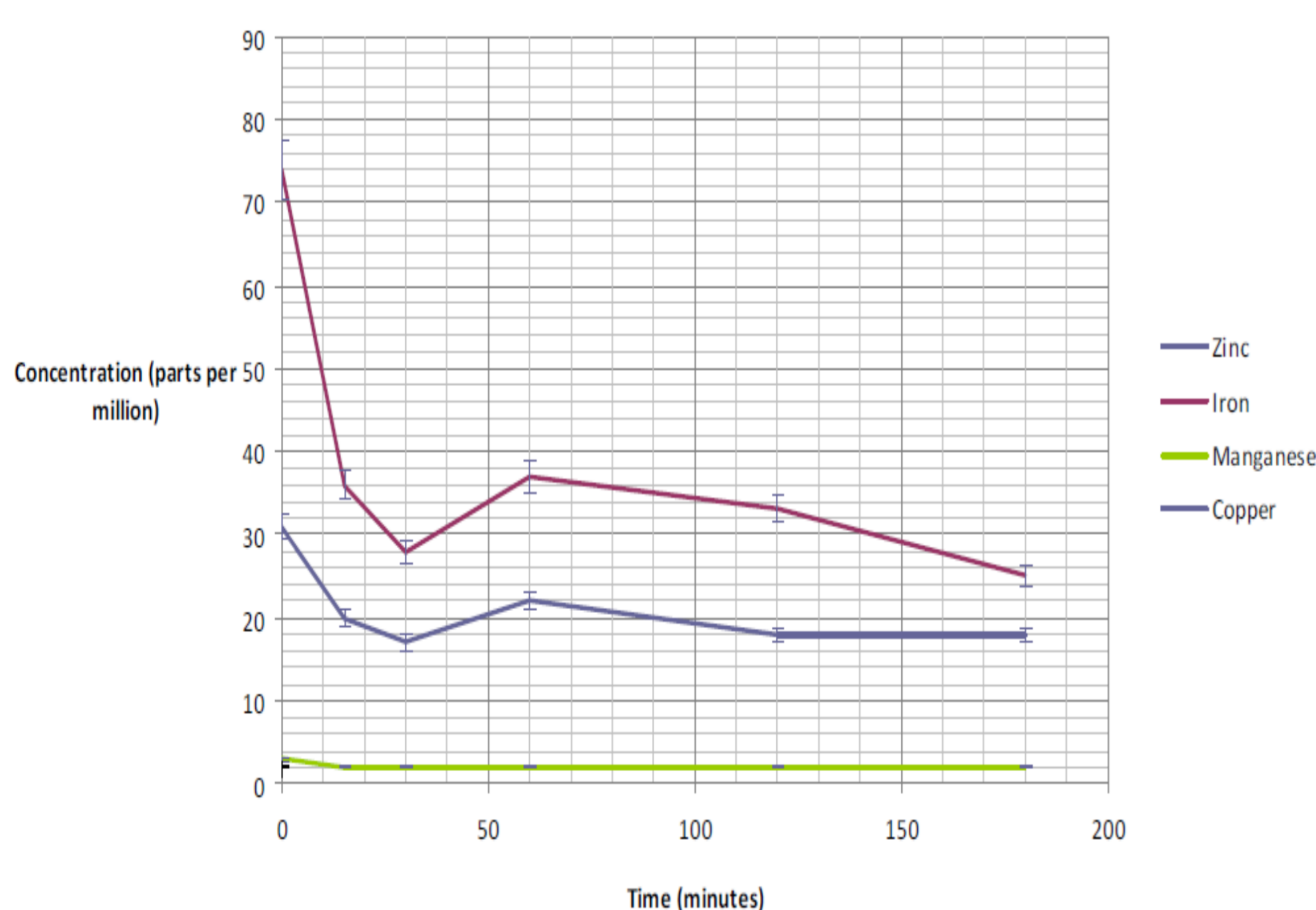

The Removal of Metal Ions from Wheal Jane Water by Material X

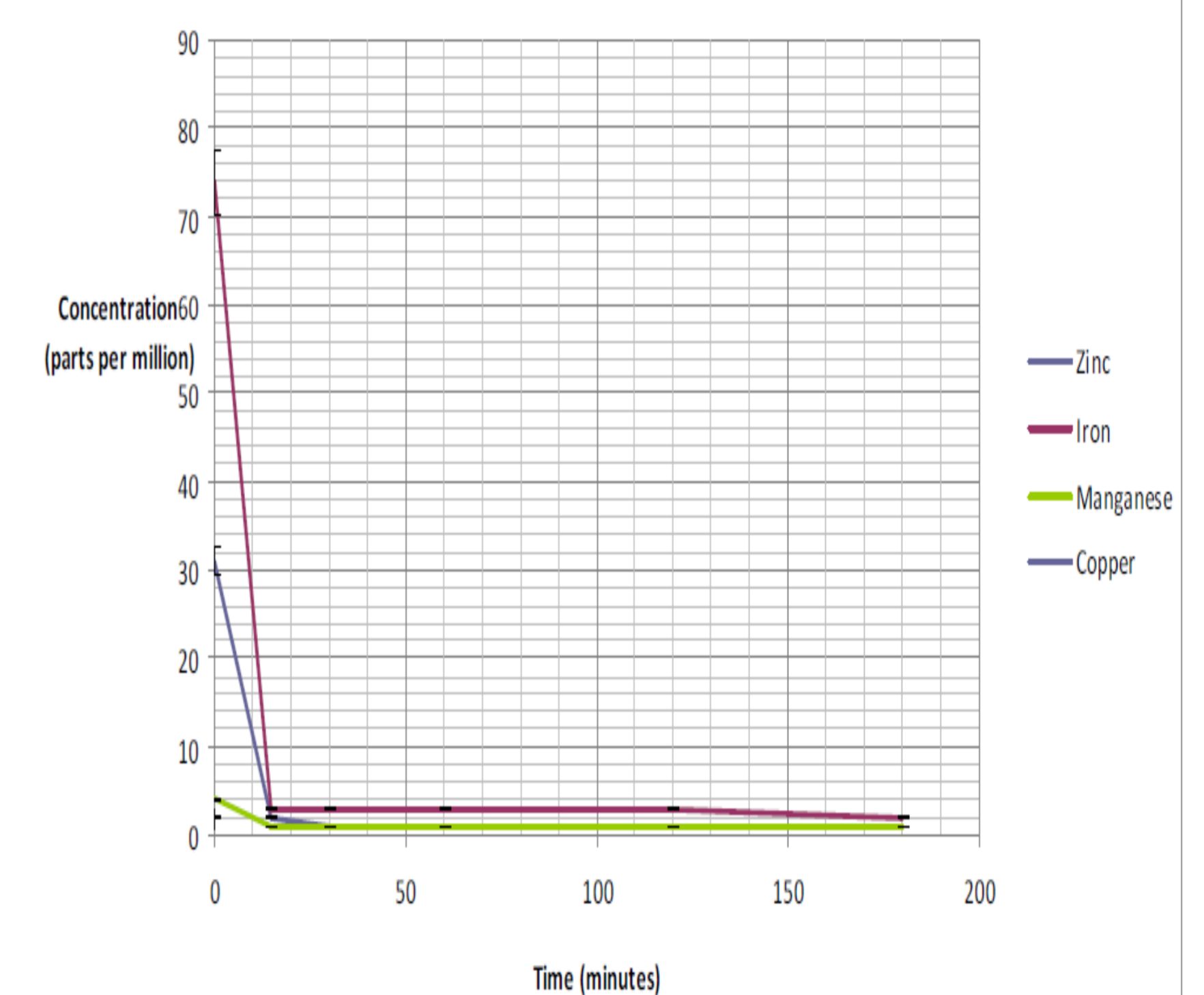

We help you invent the future™

